



Art.



VOETSPINDEL	ADJUSTABLE BASE PLATE	SOCLE RÉGLABLE FIXE		
-------------	-----------------------	---------------------	--	--



AS0001/020	0.20	2.0	500	
AS0001/030	0.30	2.5	500	
AS0001/040	0.40	3.0	500	
AS0001/050	0.50	3.6	350	
AS0001/060	0.60	4.2	350	
AS0001/080	0.80	5.3	200	
AS0001/100	1.00	6.4	200	
AS0001/130	1.30	8.1	150	
<i>massief - massive - massif</i>				
AS0001/065	0.60	6.1	350	

KANTELVOETSPINDEL 5°	ADJUSTABLE BASE PLATE 5°	SOCLE RÉGLABLE À ROTULE 5°		
----------------------	--------------------------	----------------------------	--	--



max. 5°

AS0001/140	0.60	4.3	350
------------	------	-----	-----

KANTELVOETSPINDEL	SWIVELING BASE PLATE	SOCLE RÉGLABLE À ROTULE		
-------------------	----------------------	-------------------------	--	--



max. 60°

AS0001/560	0.60	6.4	250
AS0001/580	0.80	7.6	200
AS0001/600	1.00	8.6	200

KOPSPINDEL	SWIVELING HEAD JACK	FOURCHE RÉGLABLE		
------------	---------------------	------------------	--	--



AS0001/180	0.60	6.9	200
------------	------	-----	-----

Art.



STEIGERWIEL	CASTOR WHEEL	ROUE POUR ÉCHAFAUDAGE
-------------	--------------	-----------------------



AS2000/500	500kg/0.60	9.9	1
AS2000/750	750kg/0.60	10.5	1
AS2001/000	1000kg/0.60	11.1	1

ROLSTEIGERSPINDEL	ROLLING BASE JACK	SOCLE D'ÉCHAFAUDAGE ROULANT
-------------------	-------------------	--------------------------------



AS0001/360	0.60	4.3	350
------------	------	-----	-----

VOETPLAAT	BASE PLATE	EMBASE
-----------	------------	--------



AS0001/150		1.4	1
------------	--	-----	---

ONDERSTEUNINGSVOETPLAAT	SUPPORT BASE PLATE	SUPPORT D'EMBASE
-------------------------	--------------------	------------------



AS0001/200		1.7	1
------------	--	-----	---

VOETSTUK	COLLAR	EMBASE
----------	--------	--------



AS0002/000		1.6	1
------------	--	-----	---

VOETSTUK VOOR ROLSTEIGER	TOWER COLLAR	EMBASE RALLONGÉE
--------------------------	--------------	------------------



AS0002/010		2.5	1
------------	--	-----	---

Art.



STAANDER

STANDARD

MONTANT

ROZET - ROSETTE - ROSACE 50cm

AS0003/050	0.50	3.2	340
AS0003/100	1.00	5.4	170
AS0003/150	1.50	7.8	85
AS0003/200	2.00	10.0	85
AS0003/300	3.00	14.6	85
AS0003/400	4.00	19.2	85

 ROZET - ROSETTE - ROSACE 54cm

AS0003/654	0.54	3.3	340
AS0003/708	1.08	5.7	170
AS0003/762	1.62	8.2	85
AS0003/816	2.16	10.6	85
AS0003/870	2.70	13.0	85
AS0003/924	3.24	15.4	85

STAANDER ZONDER PEN

STANDARD WITHOUT SPIGOT

MONTANT SANS GOUJON

ROZET - ROSETTE - ROSACE 50cm

AS0005/025	0.25	1.6	340
AS0005/050	0.50	2.3	85
AS0005/100	1.00	4.5	85
AS0005/150	1.50	6.8	85
AS0005/200	2.00	9.1	85
AS0005/300	3.00	13.6	85

 ROZET - ROSETTE - ROSACE 54cm

AS0005/708	1.08	4.8	85
AS0005/762	1.62	7.2	85
AS0005/816	2.16	9.7	85
AS0005/870	2.70	12.1	85
AS0005/924	3.24	16.4	85

STAANDER ZONDER PEN

STANDARD WITHOUT SPIGOT

MONTANT SANS GOUJON

AS0005/420	0.67	3.4	170
------------	------	-----	-----

Art.



**STAANDER MET DEMONTA-  
BELE PEN**

**STANDARD WITH DISMANTA-  
BLE SPIGOT**

**MONTANT AVEC GOUJON  
DÉMONTABLE**

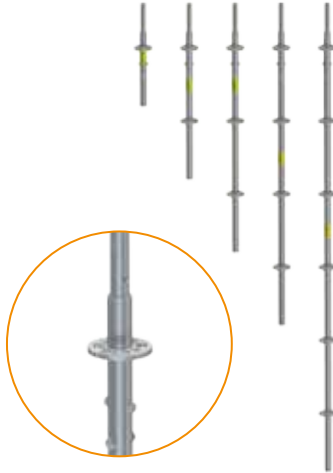

ROZET - ROSETTE - ROSACE 50cm

AS0004/050	0.50	4.1	340
AS0004/100	1.00	6.4	170
AS0004/150	1.50	8.7	85
AS0004/200	2.00	11.0	85
AS0004/300	3.00	15.5	85



ROZET - ROSETTE - ROSACE 54cm

AS0004/708	1.08	6.9	340
AS0004/762	1.62	9.1	170
AS0004/816	2.16	11.5	85
AS0004/870	2.70	14.0	85
AS0004/924	3.24	16.4	85

**ANTI-KLIMSTAANDER**

**ANTI-CLIMBING STANDARD**

**MONTANT ANTI-MONTÉE**



ROZET - ROSETTE - ROSACE 50cm

AS0003/520	2.00	8.5	85
AS0003/530	3.00	13.1	85

**STAANDERPEN**

**SPIGOT**

**GOUJON**





AS0200/100	0.58	1.8	250
------------	------	-----	-----

Art.



LIGGER	LEDGER				LISSE
		AS0006/025	0.25	1.5	300
		AS0006/036	0.36	2.0	300
		AS0006/039	0.39	2.0	300
		AS0006/045	0.45	2.2	300
		AS0006/073	0.73	3.2	300
		AS0006/103	1.03	4.3	200
		AS0006/109	1.09	4.5	200
		AS0006/140	1.40	5.6	150
		AS0006/157	1.57	6.2	150
		AS0006/207	2.07	8.0	150
		AS0006/257	2.57	9.8	150
		AS0006/307	3.07	11.5	150

VERSTERKTE LIGGER	REINFORCED LEDGER				LISSE TUBULAIRE RENFORCÉE
		AS0007/109	1.09	5.4	150
		AS0007/140	1.40	5.9	150
		AS0007/157	1.57	7.7	150
		AS0007/207	2.07	10.2	150
		AS0007/257	2.57	12.7	150

DUBBELE LIGGER	BRIDGING LEDGER				DOUBLE LISSE TUBULAIRE
		AS0008/140	1.40	8.2	80
		AS0008/157	1.57	9.1	80
		AS0008/207	2.07	12.1	80
		AS0008/257	2.57	14.8	80
		AS0008/307	3.07	17.8	80

LEUNING	GUARDRAIL				GARDE-CORPS
		AS0020/073	0.73	1.9	240
		AS0020/109	1.09	2.4	150
		AS0020/140	1.40	2.7	120
		AS0020/157	1.57	2.9	120
		AS0020/207	2.07	3.5	120
		AS0020/257	2.57	4.1	120
		AS0020/307	3.07	4.7	120

LIFE TUBE	LIFE TUBE				LIFE TUBE
		AS0021/025	1.09-1.57		120
		AS0021/050	1.57-2.57		120
		AS0021/075	2.07-3.07		120

Art.





HULPKORTELING	SUPPORT LEDGER	PORTE-PLANCHER		
	AS1050/073	0.73	3.9	200
	AS1050/109	1.09	5.2	120
	AS1050/140	1.40	6.3	100
	AS1050/157	1.57	6.9	100
	AS1050/207	2.07	8.7	100
	AS1050/257	2.57	10.5	100
	AS1050/307	3.07	12.1	100

HULPKORTELING UITSCHUIFBAAR	SUPPORT LEDGER, EXTENDED	PORTE-PLANCHER TÉLÉSCOPIQUE		
	AS1051/073	0.73	5.7	160
	AS1051/109	1.09	7.4	200
	AS1051/140	1.40	8.5	80
	AS1051/157	1.57	9.4	80

VERLENGSTUK HULPKORTE- LING UITSCHUIFBAAR	EXTENSION SUPPORT LED- GER, EXTENDED	APPENDICE PORTE-PLAN- CHER TÉLÉSCOPIQUE		
	AS1051/001	0.20	0.6	100

SPETTERPROFIEL	RETAINER PROFILE	PROFILÉ ANTI-CRAQUELURES		
	AS1052/001	1.40	5.0	100

HALVE KOPPELING MET BORGHAAK	HALF COUPLING WITH LOC- KING HOOK	DEMI-COLLIER AVEC CRO- CHET DE SÉCURITÉ		
	AS1052/002	48mm	1.0	100

STEIGERBUIS	TUBE	TUBE		
	AS0080/100	1.00	3.6	1
	AS0080/150	1.50	5.4	1
	AS0080/200	2.00	7.2	1
	AS0080/300	3.00	10.8	1
	AS0080/400	4.00	14.4	1
	AS0080/500	5.00	18.0	1
	AS0080/600	6.00	21.6	1

Art.



VERTICALE DIAGONAAL

VERTICAL DIAGONAL BRACES

DIAGONALE VERTICALE

ROZET - ROSETTE - ROSACE 50cm



AS0010/073	0.73/2.00	7.6	150
AS0010/103	1.03/2.00	7.9	150
AS0010/109	1.09/2.00	8.0	150
AS0010/140	1.40/2.00	8.3	150
AS0010/157	1.57/2.00	8.5	150
AS0010/207	2.07/2.00	9.4	150
AS0010/257	2.57/2.00	10.3	150
AS0010/307	3.07/2.00	11.4	150



ROZET - ROSETTE - ROSACE 54cm

AS0010/405	0.73/2.16	8.0	150
AS0010/410	1.09/2.16	8.3	150
AS0010/415	1.40/2.16	8.7	150
AS0010/420	1.57/2.16	8.9	150
AS0010/425	2.07/2.16	9.7	150
AS0010/430	2.57/2.16	10.6	150

ROZET - ROSETTE - ROSACE 50cm



AS0011/073	0.73/1.50	6.3	150
AS0011/103	1.03/1.50	6.7	150
AS0011/109	1.09/1.50	6.8	150
AS0011/140	1.40/1.50	7.2	150
AS0011/157	1.57/1.50	7.5	150
AS0011/207	2.07/1.50	8.5	150
AS0011/257	2.57/1.50	9.6	150
AS0011/307	3.07/1.50	10.7	150



AS0012/073	0.73/1.00	5.2	150
AS0012/103	1.03/1.00	5.6	150
AS0012/109	1.09/1.00	5.7	150
AS0012/140	1.40/1.00	6.3	150
AS0012/157	1.57/1.00	6.7	150
AS0012/207	2.07/1.00	7.8	150
AS0012/257	2.57/1.00	9.0	150
AS0012/307	3.07/1.00	10.2	150



Art.



VERTICALE DIAGONAAL	VERTICAL DIAGONAL BRACES	DIAGONALE VERTICALE
---------------------	--------------------------	---------------------

AS0013/073	0.73/0.50	4.1	150
AS0013/103	1.03/0.50	4.8	150
AS0013/109	1.09/0.50	4.9	150
AS0013/140	1.40/0.50	5.6	150
AS0013/157	1.57/0.50	6.1	150
AS0013/207	2.07/0.50	7.3	150
AS0013/257	2.57/0.50	8.6	150
AS0013/307	3.07/0.50	9.9	150



HORIZONTALE DIAGONAAL	HORIZONTAL DIAGONAL BRACES	DIAGONALE HORIZONTALE
-----------------------	----------------------------	-----------------------

AS0015/103	1.03/1.03	5.8	150
AS0015/109	1.09/1.09	6.1	150
AS0015/140	1.40/1.40	7.7	150
AS0015/157	1.57/1.57	8.5	150
AS0015/207	2.07/2.07	10.7	150
AS0015/257	2.57/2.57	13.5	150



HORIZONTALE DIAGONAAL LINKS	HORIZONTAL DIAGONAL BRACES LEFT	DIAGONALE HORIZONTALE À GAUCHE
-----------------------------	---------------------------------	--------------------------------

AS0015/600	2.07/1.03	8.9	150
AS0015/630	2.07/1.57	9.9	150
AS0015/610	2.57/0.73	10.2	150
AS0015/620	2.57/1.09	10.6	150



HORIZONTALE DIAGONAAL RECHTS	HORIZONTAL DIAGONAL BRACES RIGHT	DIAGONALE HORIZONTALE À DROITE
------------------------------	----------------------------------	--------------------------------

AS0015/601	2.07/1.03	8.9	150
AS0015/631	2.07/1.57	9.9	150
AS0015/611	2.57/0.73	10.2	150
AS0015/621	2.57/1.09	10.6	150



Art.



**STALEN VLOER**                      **STEEL DECK**                      **PLANCHER EN ACIER**

	AS0031/073	0.73/0.19	4.5	45
	AS0031/109	1.09/0.19	6.0	45
	AS0031/140	1.40/0.19	7.3	45
	AS0031/157	1.57/0.19	8.1	45
	AS0031/207	2.07/0.19	10.2	45
	AS0031/257	2.57/0.19	12.4	45
	AS0031/457	3.07/0.19	14.5	45

	AS0032/073	0.73/0.32	6.0	45
	AS0032/103	1.03/0.32	7.7	45
	AS0032/109	1.09/0.32	8.0	45
	AS0032/140	1.40/0.32	10.2	45
	AS0032/157	1.57/0.32	11.2	45
	AS0032/207	2.07/0.32	16.5	45
	AS0032/257	2.57/0.32	19.9	45
	AS0032/457	3.07/0.32	23.4	45

**AANVANGVLONDER**                      **BOTTOM EDGE OF THE RAMP**                      **RAMPE D'ACCÈS**



AS0032/600	0.83/0.32	6.5	1
------------	-----------	-----	---

**STALEN VLOER DIAGONAAL**                      **DIAGONAL STEEL DECK**                      **PLANCHER DIAGONAL EN**  
**H=0.5M**                      **H=0.5M**                      **ACIER H=0.5M**

	AS0032/605	2.07/0.32	17.0	45
	AS0032/610	2.57/0.32	20.3	45
	AS0032/615	3.07/0.32	23.6	45

**STALEN VLOER 45°**                      **STEEL DECK 45°**                      **PLANCHER EN ACIER 45°**

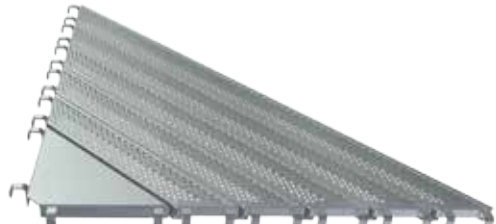
	AS0032/851	1	11.4	1
	AS0032/852	2	7.3	1
	AS0032/853	3	9.3	1
	AS0032/854	4	11.4	1
	AS0032/855	5	13.4	1
	AS0032/856	6	15.4	1

Art.



VLOER MET LUIK	ACCESS DECK	PLANCHER À TRAPPE
----------------	-------------	-------------------



AS0033/157	1.57/0.64	13.9	20
AS0033/207	2.07/0.64	17.0	20
AS0033/257	2.57/0.64	19.5	20
AS0033/207	3.07/0.64	24.0	20

ALUMINIUM - ALUMINIUM - ALUMINIUM



AS0033/510	1.09/0.64		20
AS0033/520	1.40/0.64		20
AS0033/520	1.57/0.64		20
AS0033/540	2.07/0.64		20

LADDERVLOER	ACCESS DECK WITH INTEGRATED LADDER	PLANCHER D'ÉCHELLE
-------------	------------------------------------	--------------------

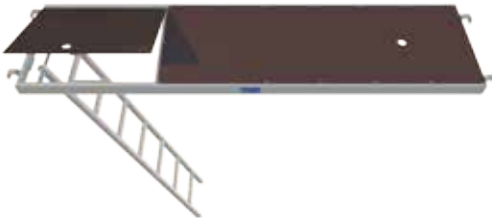

h= 2.00m

AS0034/257	2.57/0.64	25.0	20
AS0034/207	3.07/0.64	29.8	20

 h= 2.16m

AS0034/260	2.57/0.64	26.0	20
------------	-----------	------	----

ALUMINIUM - ALUMINIUM - ALUMINIUM

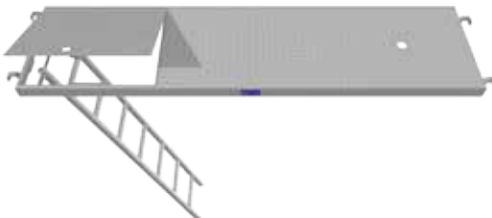

AS0034/550	2.57/0.64		20
AS0034/560	3.07/0.64		20

LADDER	LADDER	ÉCHELLE
--------	--------	---------



AS0033/001		8.7	20
------------	--	-----	----

Art.



**STALEN STEIGERPLANK      STEEL FLOOR BOARD      PLANCHER EN ACIER**



AS0032/710	1.00/0.32	4.9	50
AS0032/715	1.50/0.32	7.3	50
AS0032/720	2.00/0.32	9.7	50
AS0032/725	2.50/0.32	12.1	50

**ALU-HOUTVLOER      ALU-WOOD DECK      PLANCHER ALU-BOIS**



AS0036/073	0.73/0.64	10.9	25
AS0036/109	1.09/0.64	11.7	25
AS0036/140	1.40/0.64	12.3	25
AS0036/157	1.57/0.64	12.8	25
AS0036/207	2.07/0.64	14.4	25
AS0036/257	2.57/0.64	16.8	25
AS0036/257	3.07/0.64	18.8	25

**ALU-FIBERVLOER      ALU-FIBERDECK      PLANCHER ALU-FIBER**



AS0037/073	0.73/0.64	8.7	25
AS0037/109	1.09/0.64	9.3	25
AS0037/140	1.40/0.64	9.8	25
AS0037/157	1.57/0.64	10.2	25
AS0037/207	2.07/0.64	11.6	25
AS0037/257	2.57/0.64	13.5	25
AS0037/257	3.07/0.64	15.0	25







**STALEN HOEKVLONDER      STEEL CORNER DECK      PLANCHER D'ANGLE EN ACIER**



AS0032/500	0.36/0.36	7.4	20
AS0032/501	0.73/0.73	9.0	20

Art.



KANTPLANK	TOE BOARD			PLINTHE
		AS0040/073	0.73	2.0 240
		AS0040/109	1.09	2.9 160
		AS0040/140	1.40	3.6 120
		AS0040/157	1.57	4.1 120
		AS0040/207	2.07	5.3 120
		AS0040/257	2.57	6.5 120
		AS0040/307	3.07	7.7 120
		STAAL - STEEL - ACIER		
		AS0040/500	0.73	1.9 85
		AS0040/510	1.09	2.7 85
		AS0040/520	1.40	3.3 85
		AS0040/530	1.57	3.7 85
		AS0040/540	2.07	4.8 85
		AS0040/550	2.57	5.9 85
		AS0040/560	3.07	7.0 85
		ALUMINIUM - ALUMINUM - ALUMINIUM		
		AS0040/600	0.73	1.4 85
		AS0040/610	1.09	1.8 85
		AS0040/620	1.40	2.3 85
		AS0040/630	1.57	2.5 85
		AS0040/640	2.07	3.2 85
		AS0040/650	2.57	3.9 85
		AS0040/660	3.07	4.6 85
VERANKERING	WALL TIE			ANCRAGE FAÇADE
		AS0060/025	0.25	1.2 500
		AS0060/045	0.45	2.0 500
		AS0060/060	0.60	2.5 500
		AS0060/080	0.80	3.2 200
		AS0060/100	1.00	3.9 100
		AS0060/150	1.50	5.7 100
GELASTE OOGBOUW	WELDED EYEBOLT			BOULON À CÉLLET SOUDÉ
		AS0061/120	∅12mm 0.12	0.2 250
		AS0061/190	∅12mm 0.19	0.3 250
		AS0061/300	∅12mm 0.30	0.4 250
PLUG	EXPANDING PLUG			CHEVILLE
		AS0061/070	∅14mm 0.07	0.05 250

Art.



CONSOLE ZONDER PEN      CONSOLE WITHOUT SPIGOT      CONSOLE SANS GOUJON



AS0075/100      0.36      3.0      90

CONSOLE      CONSOLE      CONSOLE



AS0075/036      0.36      4.1      90

AS0075/073      0.73      7.0      60

UITSCHUIFBARE CONSOLE      ADJUSTABLE CONSOLE      CONSOLE EXTENSIBLE

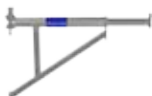

AS0075/080      0.40/0.60      5.4      90

LEUNING UITSCHUIFBARE CONSOLE      GUARD-RAIL ADJUSTABLE CONSOLE      RAMPE POUR CONSOLE EXTENSIBLE



AS0075/082      0.40/0.60      3.6      1

UITSCHUIFBARE TUSSEN-CONSOLE      ADJUSTABLE INTERMEDIATE CONSOLE      CONSOLE INTERMÉDIAIRE EXTENSIBLE



AS0075/081      0.40/0.60      6.2      60

CONSOLE BUISOPLEGGING      CONSOLE TUBE APPLICATION      CONSOLE APPLICATION TUBE



AS0075/105      0.73/0.50      6.2      40

AS0075/109      1.09/0.50      8.1      40

HIJSCONSOLE      LIFTING CONSOLE      CONSOLE POULIE

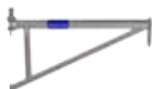

AS0075/173      0.73      8.1      60

Art.



HIJSWIEL	HOIST WHEEL				POULIE
----------	-------------	--	--	--	--------



AS0075/180

4.4

1

TOUW VOOR HIJSWIEL	CABLE FOR HOIST WHEEL				CORDE POUR POULIE
--------------------	-----------------------	--	--	--	-------------------



AS0075/525

25.0

7.1

1

MUURCONSOLE	WALL CONSOLE				CONSOLE MURALE
-------------	--------------	--	--	--	----------------



AS0075/800

3.6

1

AS0075/805

0.50

11.9

1

STEIGERLADDER	SCAFFOLDING LADDER				ÉCHELLE EN ACIER
---------------	--------------------	--	--	--	------------------



AS1080/225

2.25

17.8

20

AS1080/325

3.25

25.0

20

KRIMPFOLIEFRAME	SHRINK-FILM FRAME				CADRE DE FILM RÉTRACTABLE
-----------------	-------------------	--	--	--	---------------------------



AS2500/140

1.40

13.0

20

# ONDERDELENLIJST PARTS LIST LISTE D'ARTICLES

Art.



TRALIELIGGER MET 4 KOP-PEN	LATTICE BEAM 4 WEDGE HEADS	POUTRE DE FRANCHISSEMENT 4 TÊTES
----------------------------	----------------------------	----------------------------------



AS0054/157	1.57	18.3	20
AS0054/207	2.07	22.9	20
AS0054/257	2.57	27.4	20
AS0054/307	3.07	31.9	20

FAST-FIX TRALIELIGGER	FAST-FIX LATTICE BEAM	POUTRE DE FRANCHISSEMENT FAST-FIX
-----------------------	-----------------------	-----------------------------------



AS0052/414	2x2.07	4.14	44.9	20
AS0052/514	2x2.57	5.14	53.8	20
AS0052/614	2x3.07	6.14	62.9	20
AS0052/621	3x2.07	6.21	63.3	20
AS0052/771	3x2.57	7.71	78.5	20
AS0052/100	2x2.57	5.14	60.9	20

 ROZET - ROSETTE - ROSACE 54cm

TRALIELIGGER	LATTICE BEAM	POUTRE DE FRANCHISSEMENT
--------------	--------------	--------------------------



AS0053/325	0.40/3.25	31.5	25
AS0053/425	0.40/4.25	42.9	25
AS0053/525	0.40/5.25	52.7	25
AS0053/625	0.40/6.25	61.5	25
ALUMINIUM - ALUMINUM - ALUMINIUM			
AS0055/325	0.40/3.25	10.9	20
AS0055/425	0.40/4.25	14.9	20
AS0055/525	0.40/5.25	18.2	20
AS0055/625	0.40/6.25	21.3	20
AS0055/725	0.40/7.25	26.0	20
AS0055/825	0.40/8.25	28.4	20

TRALIELIGGER ADAPTER	LATTICE BEAM WALL CONNECTOR	FIXATION MUR POUR POUTRE
----------------------	-----------------------------	--------------------------



AS0053/900	0.40	12.0	1
------------	------	------	---

VERBINDER TRALIELIGGER	LATTICE BEAM CONNECTOR	GOUJON DE POUTRE DE FRANCHISSEMENT
------------------------	------------------------	------------------------------------



AS0053/990	0.50	9.9	1
BOUT+MOER - BOLT+NUT - BOULON+ECROU			
AS0300/100	M12 x 60mm	0.05	1
AS0300/101	M12	0.05	1



Art.



KOMBILIGGER	LEDGER WEDGE HEAD/TUBE	LISSE COMBINÉE
-------------	------------------------	----------------

	AS0009/073	0.73	3.7	250
	AS0009/109	1.09	4.9	200
	AS0009/140	1.40	6.0	120
	AS0009/157	1.57	6.7	120

RAVEELKORTELING	LEDGER TUBE-APPLICATION DECK/DECK	LISSE APPLICATION PLANCHER/PLANCHER
-----------------	--------------------------------------	----------------------------------------

	AS0009/401	0.32	3.2	250
	AS0009/402	0.64	4.3	200
	AS0009/403	0.96	5.5	120

KOMBI-RAVEELKORTELING	LEDGER TUBE/STEEL DECK	LISSE APPLICATION TUBE/PLANCHER
-----------------------	------------------------	------------------------------------

	AS0009/501	0.32	3.2	250
	AS0009/502	0.64	4.3	200
	AS0009/503	0.96	5.6	100

ADAPTER STAANDER	ADAPTOR STANDARD	ADAPTATEUR STANDART
------------------	------------------	---------------------

	AS0003/540	0.50	4.5	10
------------------------------------------------------------------------------------	------------	------	-----	----

VEILIGHEIDSPOORT	SWINGING SAFETY RAILING	DOUBLE BARRE DE SÉCURITÉ
------------------	-------------------------	--------------------------

	AS2500/050	1.00/1.00	10.4	10
-------------------------------------------------------------------------------------	------------	-----------	------	----

Art.



**ALUMINIUM STEIGERTRAP**    **ALUMINIUM PLATFORM STAIR**    **VOLÉE D'ESCALIERS ALUMINIUM**



AS0050/157	1.57/1.00	24.2	1
AS0050/207	2.07/1.50	25.6	1
AS0050/257	2.57/2.00	27.8	1
 <b>ROZET - ROSETTE - ROSACE 54cm</b>			
AS0050/266	2.57/2.16	29.1	1

**TRAPLEUNINGHOUDER**    **STAIRWAY GUARD-RAIL ADAPTER**    **SUPPORT DE RAMPE**



AS0050/400	-	0.7	500
------------	---	-----	-----

**BUITENLEUNING**    **STAIR GUARD-RAIL**    **RAMPE EXTÉRIEURE**

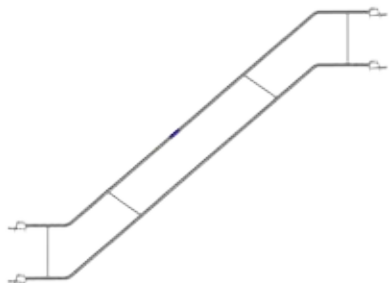

AS0050/290	1.57/1.00	10.7	20
AS0050/295	2.07/1.50	13.0	20
AS0050/300	2.57/2.00	14.7	20
 <b>ROZET - ROSETTE - ROSACE 54cm</b>			
AS0050/310	2.57/2.16	15.7	20

**BINNENLEUNING**    **INTERNAL GUARD-RAIL**    **RAMPE INTÉRIEURE**



AS0050/510	1.57/1.00	10.2	20
AS0050/515	2.07/1.50	13.1	20
AS0050/520	2.57/2.00	15.3	20
 <b>ROZET - ROSETTE - ROSACE 54cm</b>			
AS0050/525	2.57/2.16	15.5	20



BEGIN/EINDSTUK	START/END PART	SUPPORT DE RAMPE	
----------------	----------------	------------------	--



	AS0050/560	-	1.9 250
--	------------	---	---------

TUSSENSTUK BINNENLEUNING	INTERMEDIATE ELEMENT	ÉLÉMENT INTERMÉDIAIRE	
--------------------------	----------------------	-----------------------	--



	AS0050/535	1.57/1.00	3.6 60
	AS0050/540	1.50/2.07	4.2 60
	AS0050/545	2.57/200	5.7 60
	ROZET - ROSETTE - ROSACE 54cm		
	AS0050/550	2.57/2.16	5.9 60

BALLUSTER	BALUSTER	BALUSTRE	
-----------	----------	----------	--



	AS0050/561	-	2.8 200
--	------------	---	---------

ALUMINIUM STEIGERTRAP STEUNEND OP VLOER	ALUMINUM PLATFORM STAIR SUPPORTED ON FLOOR	VOLÉE D'ESCALIERS ALU REPOSANT SUR PLANCHER	
--------------------------------------------	-----------------------------------------------	------------------------------------------------	--



	AS0050/050	0.94/0.50	11.0 1
	AS0050/100	1.44/1.00	14.8 1
	AS0050/150	1.94/1.50	25.3 1

EINDBINNENLEUNING	END INTERNAL GUARD-RAIL	ÉLÉMENT FINAL DE RAMPE INTÉRIEURE	
-------------------	-------------------------	--------------------------------------	--



	AS0050/360	1.00	- 20
	AS0050/365	1.50	15.3 20

BINNENLEUNING BOVENBOR- DES	INTERNAL GUARDRAIL OF THE TOP LADDER	GARDE-CORPS INTÉRIEUR DE L'ESCALIER DESSUS	
--------------------------------	-----------------------------------------	-----------------------------------------------	--



	AS0050/XXX	-	- 1
--	------------	---	-----

Art.



LANGSDRAGER	HEAD-BEAM		POUTRE LONGITUDINALE		
-------------	-----------	--	----------------------	--	--



AS0082/103	1.03	7.5	40
AS0082/207	2.07	16.1	

DWARSDRAGER	CROSS-BEAM		POUTRE TRANSVERSALE		
-------------	------------	--	---------------------	--	--



AS0082/217	2.07	14.6	50
------------	------	------	----

HULPDRAGER	INTERMEDIATE BEAM		BARRE DE SUPPORT		
------------	-------------------	--	------------------	--	--



AS0082/227	2.07	9.7	70
------------	------	-----	----

PODIUMVLOER PRO	STAGE FLOOR PRO		PLANCHER DE SCÈNE PRO		
-----------------	-----------------	--	-----------------------	--	--



AS0082/237	2.07/1.03	21.3	85
------------	-----------	------	----

PANEELBEVESTIGING	PANEL FIXATION		SUPPORT POUR PANNEAU		
-------------------	----------------	--	----------------------	--	--



AS0082/020		0.7	500
------------	--	-----	-----

RUBBER DOP	RUBBER TAP		CAPUCHON CAOUTCHOUC		
------------	------------	--	---------------------	--	--



AS0051/000	Ø48.3mm	0.1	500
------------	---------	-----	-----

EINDDOP LEUNING	GUARDRAIL TAP		BOUCHON DE GARDE-CORPS		
-----------------	---------------	--	------------------------	--	--



AS0051/005	Ø41/48.3mm	0.1	500
------------	------------	-----	-----

Art.



PODIUM BEAM	PODIUM BEAM	POUTRE ÉTAGE	
-------------	-------------	--------------	--



AS0084/005	0.52	85
AS0084/010	1.03	85
AS0084/015	1.55	85
AS0084/020	2.07	85
AS0084/050	0.50	85
AS0084/055	1.00	85
AS0084/060	1.50	85
AS0084/065	2.00	85

PODIUMDECK	PODIUMDECK	POUTRE ÉTAGE	
------------	------------	--------------	--



AS0084/105	0.52/0.52	50
AS0084/110	1.03/0.52	50
AS0084/115	1.55/0.52	50
AS0084/120	2.07/0.52	50
AS0084/125	1.03/1.03	50
AS0084/130	1.55/1.03	50
AS0084/135	2.07/1.03	50
AS0084/155	0.50/0.50	50
AS0084/160	1.00/0.50	50
AS0084/165	1.50/0.50	50
AS0084/170	2.00/0.50	50
AS0084/175	2.00/1.00	50
AS0084/180	1.50/1.00	50
AS0084/185	2.00/1.00	50

BORGCLIP DECK/BEAM	CLIP DECK/BEAM	GOUPILLE PLATE-FORM/POUTRE	
--------------------	----------------	----------------------------	--



AS0084/200	0.1	100
------------	-----	-----

CLAMP DECK/DECK	CLAMP DECK/DECK	ÉTAU PLATE-FORM/PLATE-FORM	
-----------------	-----------------	----------------------------	--



AS0084/201	0.1	100
------------	-----	-----

Art.



TRAPBOOM	STRINGER			LIMON
----------	----------	--	--	-------

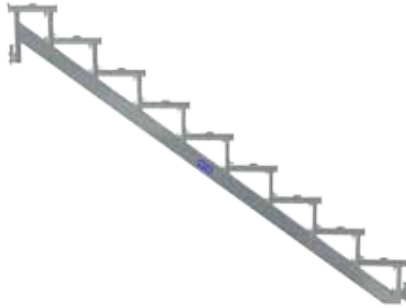

AS0051/103	1.03/0.50	9.9	30
AS0051/157	1.57/1.00	23.8	30
AS0051/250	2.57/1.50	35.1	30
AS0051/257	2.57/2.00	36.9	30

PUBLIEK HEK	SAFETY GUARDRAIL			GARDE-CORPS H=1.10M
-------------	------------------	--	--	---------------------



VOOR TRAPBOOM - FOR STRINGER  
SÛR POUR LIMON

AS0051/305	1.03/0.50	16.3	1
AS0051/310	1.57/1.00	23.6	1
AS0051/315	2.57/1.50	36.5	1
AS0051/320	2.57/2.00	37.6	1

VOOR RAMP - FOR RAMP POUR RAMPE

AS0051/605	2.07/0.50	29.5	1
AS0051/610	2.57/0.50	35.4	1
AS0051/615	3.07/0.50	41.2	1

PUBLIEK HEK	RAILING WITH SAFE GUARDRAIL			GRILLE AVEC GARDE-CORPS SÛR
-------------	--------------------------------	--	--	--------------------------------

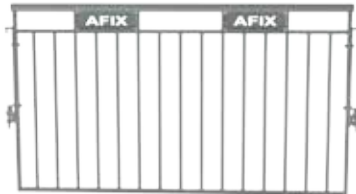

AS0051/400	0.73/1.10	12.6	1
AS0051/405	1.09/1.10	18.6	1
AS0051/410	1.40/1.10	21.1	1
AS0051/415	1.57/1.10	22.8	1
AS0051/420	2.07/1.10	31.2	1
AS0051/425	2.57/1.00	37.6	1
AS0051/430	3.07/1.10	40.8	1

Art.



**DRAAIKOPPELING**      **SWIVEL COUPLER**      **COLLIER ORIENTABLE**



AS0100/100	ø48/48mm	1.6	25
AS0100/104	ø48/38mm	1.6	25
AS0100/108	ø48/42mm	1.7	25
AS0100/116	ø48/60mm	1.9	25
AS0100/118	ø48/76mm	2.1	25

**KRUISKOPPELING**      **DOUBLE COUPLER**      **COLLIER ORTHOGONAL**



AS0100/200	ø48/48mm	1.6	25
AS0100/202	ø42/42mm	1.7	25
AS0100/204	ø48/38mm	1.6	25
AS0100/208	ø48/42mm	1.7	25
AS0100/216	ø48/60mm	1.9	25
AS0100/218	ø48/76mm	2.1	25

**HALVE KOPPELING**      **HALF COUPLER**      **DEMI-COLLIER**



AS0100/220	ø48mm	0.8	50
------------	-------	-----	----

**KANTPLANKKOPPELING**      **HALF COUPLER WITH TOE BOARD BOLT**      **COLLIER FIXE PLINTHE**



AS0100/221	ø48mm	1.2	20
------------	-------	-----	----

**RINGKOPPELING**      **RING COUPLER**      **RACCORD ANNULAIRE**



AS0100/222	ø48mm	1.0	25
------------	-------	-----	----

**BALKHAAKKOPPELING**      **CLAMPING COUPLER**      **COLLIER CRAPAUD**



AS0100/250	ø48mm	1.1	25
------------	-------	-----	----

**GORDINGKOPPELING**      **TIMBER COUPLER**      **COLLIER BOIS-ACIER**



AS0100/260	ø48mm	2.0	20
------------	-------	-----	----

Art.



VERANKERINGSKOPPELING ANCHORING COUPLER COLLIER D'ANCRAGE



AS0100/228 ø48mm 1.7 20

LASKOPPELING JOINT COUPLER COLLIER SIMPLE



AS0100/230 ø48mm 1.8 20

TRALIELIGGERKOPPELING LATTICE BEAM COUPLER COLLIER POUR POUTRE DE FRANCHISSEMENT



AS0100/270 ø48mm 1.8 20

SPIEKOP DRAAIKOPPELING WEDGE HEAD COUPLER, SWIVELING COLLIER ORIENTABLE À TÊTE À CLAVETTE



AS0100/350 ø48mm 1.7 25

SPIEKOP KRUISKOPPELING WEDGE HEAD COUPLER, RIGID COLLIER ORTHOGONAL À TÊTE À CLAVETTE



AS0100/380 ø48mm 1.4 25

ROZETKOPPELING ROSETTE, CLAMPABLE COLLIER ROSACE



AS0100/400 ø48mm 0.8 25

DUBBELE SPIEKOP WEDGE HEAD COUPLER, DOUBLE TÊTE À CLAVETTE DOUBLE



AS0100/390 150mm 0.8 25



Art.



STAANDERPEN + HALVE KOPPELING	SPIGOT WITH COUPLER	GOUJON AVEC DEMI-COLLIER
----------------------------------	---------------------	--------------------------



AS0200/105	ø48mm	1.8	20
------------	-------	-----	----

FAST FIX VERBINDING	FAST FIX-FIXTURE	RENFORT FAST FIX
---------------------	------------------	------------------



AS0200/200	0.5	2.2	20
------------	-----	-----	----

HAMERKOPBOUT + MOER	HAMMER HEAD BOLT + NUT	BOULON TÊTE MARTEAU + ÉCROU
---------------------	------------------------	--------------------------------



AS0100/500	M14 x 70mm	0.1	200
------------	------------	-----	-----

HAMERKOPBOUT - HAMMER HEAD BOLT - BOU-  
LON TÊTE MARTEAU

AS0100/501	M14	0.05	500
------------	-----	------	-----

MOER - NUT - ÉCROU

AS0100/502	M14	0.05	200
------------	-----	------	-----









SPIE + KLINKNAGEL	WEDGE + RIVET	CLAVETTE + RIVETS
-------------------	---------------	-------------------



AS0400/201		0.1	200
------------	--	-----	-----

Art.



BORGPEN	LOCKING PIN				
		AS0400/202	0.1	200	
BORGCLIP	LOCKING CLIP				
		AS0400/205	0.1	200	
LASPEN	SPRING BOLT				
		AS0100/231	1.2	25	
KRUISKOPPELING VASTE SPIE	DOUBLE COUPLER + WOOD-RUFF KEY				
		AS0100/201	∅48/48mm	1.8	25
DRAAIKOPPELING VASTE SPIE	SWIVEL COUPLER + WOOD-RUFF KEY				
		AS0100/101	∅48/48mm	1.8	25
RATELSLEUTEL	RATCHET WRENCH				
		AS0417/022	19/22mm	0.3	30
TAKEL	PULLEY BLOCK				
		CL0000/200	200kg	?	1
		CL0000/500	500kg	?	1
STEIGERKAART	SCAFFOLD CARD				
		AS0400/250			1
		AS0400/300			50

Art.



ECOPALLET GELAKT

ECOPALLET PAINTED

ÉCOPALETTE PEINT

AS9125/010 1.10/0.6/0.9 ? 1



PALLET VOOR VLOEREN

PALLET FOR DECKS

PALETTE POUR PLANCHERS

AS9125/063 30x 35.9 1



CONTAINERPALLET

CONTAINER PALLET

PALETTE CONTENEUR

AS9125/080 1.25/0.85/0.7 ? 1

AS9125/081 1.25/0.85/0.9 108.7 1



STAPELPALLET

STACKING PALLET

PALETTE EMPILABLE

AS9125/085 1.25/0.85/0.9 31.0 1

+ HIJSOGEN - + EYEBOLTS - + CEILLETONS DE LEVAGE

AS9125/090 1.25/0.85/0.9 34.8 1



### **België:**

Durmelaan 20  
9880 Aalter  
België

Tél. +32 9 381 61 01  
Fax +32 9 381 61 00  
E-mail [info@afixgroup.com](mailto:info@afixgroup.com)

### **Nederland:**

Koopvaardijweg 6  
4906 CV Oosterhout  
Nederland

Tél. +31 162 43 51 51  
Fax +31 162 43 98 28  
E-mail [info@afixgroup.com](mailto:info@afixgroup.com)

### **Mauritius:**

C/O Interface Management Services LTD  
9th Floor, Raffles Tower 19  
Cybercity, Ebene  
Maurice

Tél. +230 404 6030  
Mob +230 499 0920  
E-mail [info@afixgroup.com](mailto:info@afixgroup.com)

### **Turkije:**

Ofis/Depo adres: Orhanlı merkez Mah. Derviş sok.  
No: 24/1  
PK 34956 Orhanlı/Tuzla Gat Lojistik Genel  
Müdürlük binası  
VD: TUZLA / VN: 0080773715 SİCİL NO: 781569

Tél. +90 216 639 40 08  
Fax +90 0216 639 40 09  
E-mail [info@afixgroup.com](mailto:info@afixgroup.com)

### **Marokko:**

Hayati AVCI  
Route de Sidi Bouzid / O.C.P  
El Jadida

Tél. +212 523 383 952  
E-mail [info@afixgroup.com](mailto:info@afixgroup.com)

### **Nigeria:**

14th floor, Churchgate Tower, AfriBank Road,  
Victoria Island, Lagos

E-mail [info@afixgroup.com](mailto:info@afixgroup.com)

### **Romania and Bulgaria:**

FET International Services SRL  
Strada Turnului nr. 5  
500152 Braşov, Romania

Mob. +40 727 82 39 82  
Tel. +40 368 46 95 45  
E-mail [info@fet-is.eu](mailto:info@fet-is.eu)  
[eli.koster@fet-is.eu](mailto:eli.koster@fet-is.eu)

### **Qatar:**

Sanam Services WLL  
(Bin Arbaid Group)  
P. O Box 60072, Al Khor, Qatar.

Tel.: +974 4472 1849  
+974 4472 1875  
Mob.: +974 6679 3307  
Fax +974 4472 2680  
E-mail [manager.sanam@binarbaid.com](mailto:manager.sanam@binarbaid.com)

